

**Roof fan in plastic**

<b>Agent:</b>	COLASIT AG – Faulenbachweg 63 – CH-3700 Spiez Phone: +41 33 655 61 61 – Fax: +41 33 654 81 61 e-mail: <a href="mailto:info@colasit.ch">info@colasit.ch</a>
COLASIT Order No.:	_____
Fan type:	_____
Year of manufacture:	_____

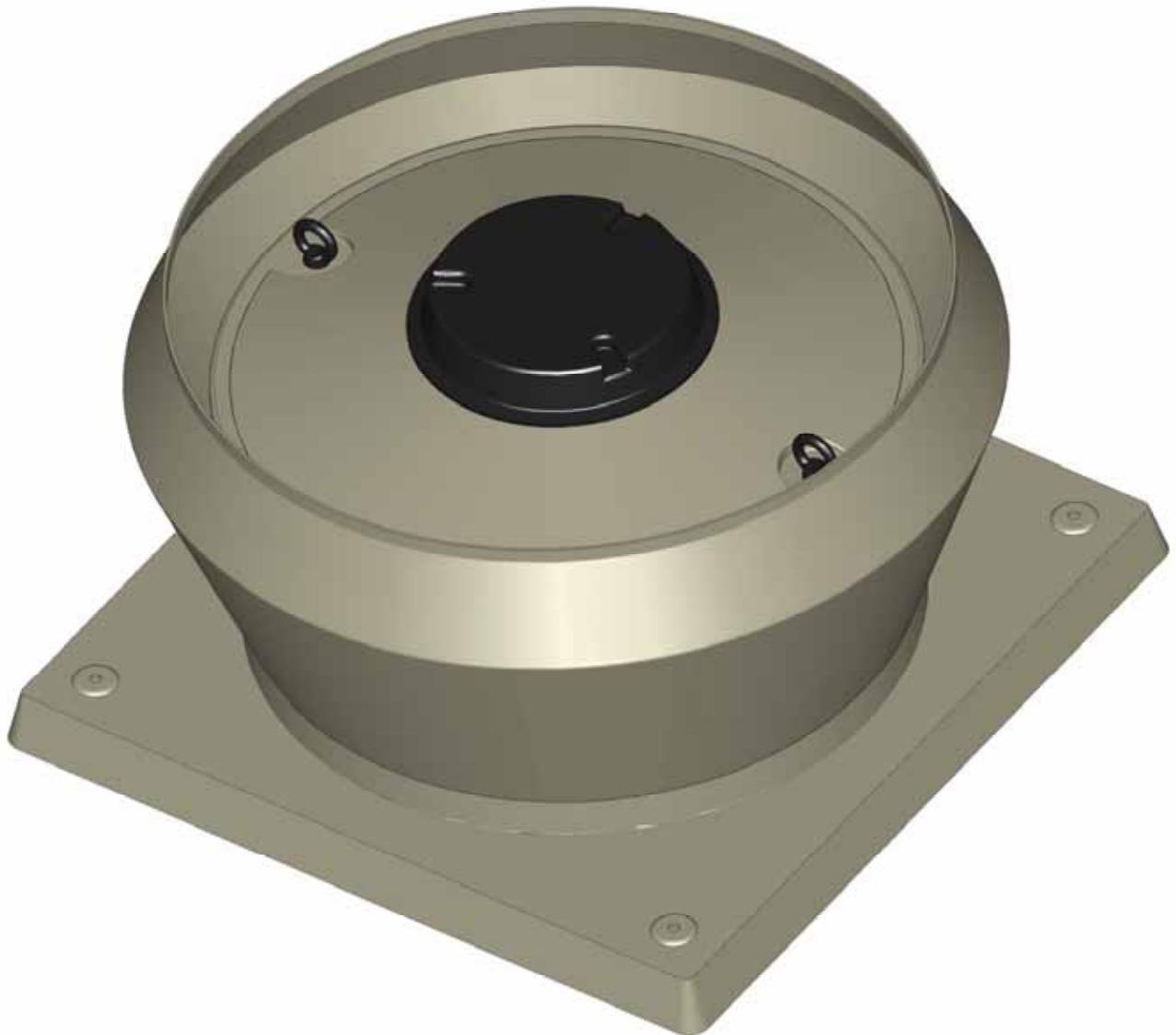



TD-000 812-E

## Preface

This operating manual is the driver's license for operation of this COLASIT fan. It is the main source of information and also the safety guideline. It deserves your full attention - please read it carefully.

The contents of this operating manual are subject to change without notice in order to take technical progress into account.

The manual contains icons that appear in the margin and indicate special dangers and important instructions.

	Very important note
	Universally applicable warnings which concern your personal safety.
	Indicates electrical dangers.
	Indicates process control dangers.

The entire operating manual consists of 3 parts:

Part 1: General

Part 2: Components

Part 3: Certificates

## Table of contents

Part 1: General .....	4
1 General .....	4
1.1 Definition .....	4
1.2 Production of COLASIT-fans .....	4
1.3 Warranty .....	4
1.4 Safety review .....	5
1.5 Personnel qualifications .....	5
1.6 Possible emergencies .....	5
1.7 Safety officer (SO) .....	5
1.8 General risk matrix .....	6
1.9 EC conformity of the COLASIT fan .....	7
1.10 Restrictions when commissioning .....	7
1.11 General operation conditions .....	7
2 Shipping, unpacking, inspection, storage .....	7
3 Installation, configuration .....	8
4 Commissioning, initial startup, test run .....	8
4.1 Inspection of the installation and settings .....	8
4.2 Drive .....	9
4.3 Electrical installations, EMERGENCY STOP .....	9
5 Operation .....	9
5.1 Safety instructions .....	9
5.2 Putting out of operation .....	10
6 Maintenance, repair, cleaning .....	10
6.1 Preparation .....	10
6.2 Performance .....	10
7 Spare parts .....	11
8 Operating instructions .....	11
9 Logbook .....	11
10 Disposal .....	11
11 Troubleshooting .....	12
12 Retrofittable original accessories .....	12
Part 2: Units .....	12
13 Design and function of the CDVA .....	12
14 Dimensional drawings .....	13
14.1 Dimensions of the CDVA .....	13
Part 3: Certification .....	14
15 Certifications .....	14
15.1 CE Manufacturer's declaration .....	14
15.2 Further certificates .....	15

# Part 1: General

## 1 General

### OBLIGATIONS

Prior to any work done on or with the fan, we place you under an obligation to read this operating manual and any further contractors' operating instructions carefully and through to the end.

Should anything not be clear, please get in touch with us immediately. Do not put the fan into operation as long as uncertainties exist.

As soon as you start up the fan you confirm that you have read and understood the operating manual.



After acquainting yourself with the fan and its operational performance together with your production processes, we recommend that you make a note of the different modes of operation in a "process instruction".

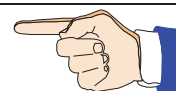

Together with this operating manual, any acceptance documents, works acceptance certificates and the EC Declaration of Conformity, the process instruction forms part of the complete system documentation.

**For the fan, a separate risk analysis was conducted as a prerequisite for writing this operating manual. Risks were evaluated and any remaining residual risks are pointed out in this operating manual.**

When extracting aggressive gases, it is imperative to review the suitability of the materials:

- Once the principal or the operator has notified us of the gas mix and the maximum operating temperature, the suitability and any applicable restrictions will be confirmed in the data sheet of COLASIT AG.
- **In the absence of a written notification with regard to the extracted medium by the principal, the operator is responsible without limitation for assessing the suitability for the operation of the ventilator.**

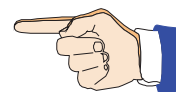

### 1.1 Definition

The term "COLASIT fan" stands for a Swiss high-quality product and contains all the components and individual parts as specified in the purchase order or in the material parts list, which, when assembled, form a functional unit.

### 1.2 Production of COLASIT-fans

The fan was manufactured using modern production methods and was extensively tested both during manufacture and as a finished product by the COLASIT quality assurance system. The methods and processes used in production and monitoring correspond to the state of the art. The personnel entrusted with production of the fan have the appropriate skills and possess valid qualifications. All fans with engine are subjected to a successful test run at the manufacturer's production facilities.

### 1.3 Warranty

Warranty ends on the date stated in the general terms of sale and delivery. Warranty is limited to the delivery of spare parts or the repair of defective parts at the manufacturer's factory. Any further claims or the replacement of non-repairable or wear parts are excluded.

We guarantee the availability of spare parts identical in construction to the original over a period of 10 years effective from the date of delivery.

COLASIT only guarantees the durability of materials on condition that technological data was available before production.  
Any change in the conditions of use is only permissible after approval by COLASIT; otherwise this will entail loss of warranty.  
Any changes or repair work during the warranty period may only be made by our fitters or with our written consent.  
We refer to the limitation of warranty noted in the "Motor"-section in the case where a frequency converter supplied by a third party is fitted.

The fan must be deployed and used in accordance with the conditions mentioned in this operating manual. Only in this way can its function be guaranteed and dangers to persons and material be excluded during operation. We accept no liability nor guarantee any claims for damages arising from nonobservance of this manual or from inappropriate operation



## **1.4 Safety review**

After installing the fan, we recommend the operator conducts a review of the entire operational environment. In this way it can be guaranteed that neither the fan will suffer damage nor that the fan will cause any damage.

## **1.5 Personnel qualifications**

The fan may only be put into operation, handled, operated, maintained and cleaned by trained personnel who are authorised (and competent) to carry out such work.  
The personnel must possess the appropriate skills needed to operate the fan and be familiar with the effects of the reactions caused by the fan.  
The personnel qualified to operate the fan must be able to react adequately and correctly in case of a fault or an emergency.

## **1.6 Possible emergencies**

An emergency may result from the bursting or melting of plastic components as a result of mechanical damage or chemical and thermal influences. In this case, parts may fly off or vapour may be produced that may be hot, corrosive, poisonous, irritating or inflammable (e.g. hydrochloric acid vapour occurring from burning PVC).  
There may be a danger of fire under certain circumstances.  
For the choice of the correct fire-extinguishing devices and the positioning of the firefighting equipment, please follow the recommendations of your local fire station.

## **1.7 Safety officer (SO)**

The function of the safety officer or his representative is defined in the operating company's organisational chart. The name of the person must be known to all personnel who are responsible for the fan.  
The operating company defines his competencies and his area of responsibility.  
The safety officer approves the fan for operation.

## 1.8 General risk matrix

### Operation

The safety regulations prevailing at the operator's location are mandatory and must be observed at all times. Before making an intervention, the process must be stopped, i.e. all mechanical movement must be stopped and it must be ensured that no automatic motion can occur.



### Missing safety devices

If the fan is equipped with safety devices, they may neither be modified nor removed. Further safety devices of suitable design must be fitted by the operator and are subject to his control.



### Disregard of safety precautions

Please implement all safety measures so that the fan, together with its associated equipment, can operate properly and any danger to persons, materials and products can be excluded.



### Putting the fan out of operation

In the case of damage to or failure of safety devices, the fan must be stopped and put out of operation. It may only be put into operation again when the safety devices are fully functional again.



### Electricity

When any work is carried out on the fan, the electric motor must be deenergised and secured to prevent it from switching on. The main power switch must be secured against operation by third parties using a lockable device (e.g. padlock) by the persons working on the fan. **Full disconnection of the motor is only permissible in case of complete removal!**

The safety regulations for work on electrical equipment prevailing at the place of operation must be observed at all times and be available for reference at the place of operation.



### Electrostatic charge

Media flowing through the plastic components may cause the buildup of electrostatic charge. These are harmless to persons who do not react to electrical impulses in the body

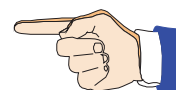

### Unsuitable materials

Through the use of inappropriate materials, the fan and/or parts may be damaged or become non-functional. Please always use original spare parts and contact the manufacturer in any case of doubt.



### Dangerous media

Depending on the mode of operation, fan parts may come in contact with dangerous media.

Work on the fan or carrying out maintenance work is not allowed during operation. Before carrying out any work, any dangerous media must be removed from the system and, when required, must be neutralized and secured in such a way that an inflow of dangerous media is prevented.



## 1.9 EC conformity of the COLASIT fan

The fan was designed, built and tested to Directive 2006/42 EC.

In addition to this EC Directive and EN standards which have the equivalent status of a Swiss standard, Swiss safety and accident-prevention regulations have also been taken into account.

An EC Declaration of Conformity in terms of the EC guidelines 2006/42 EC on machines will be issued along with the fan.

## 1.10 Restrictions when commissioning

We stipulate that putting into operation is prohibited as long as the fan, including all parts belonging to it or equipment connected to it, has not been installed and checked out and until the operating manual has been read completely before commissioning.

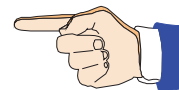

We stipulate that the fan may only be put into operation when the safety inspector has given his approval. He is obliged to record this approval in a protocol.

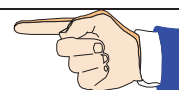

The disregard of these stipulations constitutes negligence.

## 1.11 General operation conditions

The permissible operating conditions are indicated on the manufacturer's plate.

The fan is not suitable for the transport of solids in the air flow. This operating mode will lead to the destruction of the fan.

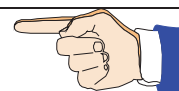

The ducts on the intake and delivery sides must always be open. A closed duct will lead to a rise in temperature which could cause the destruction of the fan.

The minimum air speed through the fan is 3 meters per second.

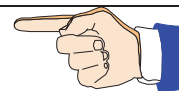

The standard motors are designed for normal operating conditions (ambient temperature +40°C, altitude below 1000 m above sea level, air pressure up to 1050 hPa). In case of any divergence from these conditions, please contact COLASIT.

Compliance with these operating conditions is the responsibility of the operator.

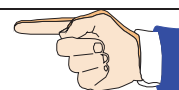

## 2 Shipping, unpacking, inspection, storage

The fan is completely assembled and can be delivered in a closed film wrapping. Please make sure the delivery corresponds to the shipping documents.

Please examine the packaging for external damage and report any damage immediately to the transport company, the supervisor and the manufacturer.

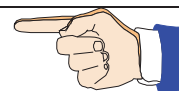

Please handle the fan with care. During transportation, only apply strain on the steel parts. Plastic is sensitive to impact and knocks, especially in the temperature range under +5°C.

When the film is removed, the intake and pressure nozzles are open and unprotected against the intrusion of foreign objects. Therefore, please do not remove the protective film until shortly before final installation.

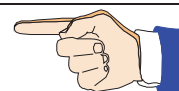

## Storage

If the fans are not put into operation immediately, store them in a clean dry place where they are protected from impacts, vibrations, and temperature fluctuations and where the air humidity is under 90%.

If these storage conditions are not available, switch the fans on at regular intervals to exclude the risk of condensate forming. Before switching on, unscrew the condensate drain plugs each time and replace them afterwards.

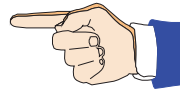

Store the fan in a dry, weather-protected place and cover with a tarpaulin to protect it from dust and soiling.

If stored for over one year, test whether the fan bearings rotate freely before putting into operation.

## 3 Installation, configuration

Before installation, check whether all the locking screws (including the motor screws) are tightened properly.  
Check the electrical connections if wired at the factory.



Before installation, check that there are no foreign bodies in the coil or in the intake and pressure connections.

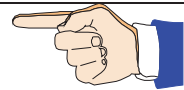

The fan must be installed at a location provided and prepared by the customer and must be secured and connected in such a way that any possible vibration occurring can be absorbed by the vibration dampers supplied by COLASIT.

If no ducting is foreseen on the intake side, the intake connection should be protected by a sturdy protective grating according to IP 20 (12mm mesh) to be provided by the customer. If small particles can be sucked in which could cause damage to the fan, a protective grating with a correspondingly smaller mesh must be fitted.

Connection ducting on the pressure side must be routed to prevent the backflow of foreign bodies, rainwater or condensate into the fan. To ensure this, please use the COLASIT condensate drain nozzles.

Due to the possibility of noise nuisance, we recommend that the fan should not be installed in the immediate vicinity of workplaces.

## 4 Commissioning, initial startup, test run

The fan should only be put into operation after inspection and approval by the safety officer.

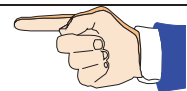

### 4.1 Inspection of the installation and settings

Check list:

Prior to commissioning and initial start-up, it must be guaranteed that

- the fan is installed vibration-free and mechanically secured,
- all components are cleaned both on the inside and the outside and are free from foreign bodies,
- all intake and pressure ducts connections are leak-proofed
- all rotating parts are protected against unintentional contact,
- the electrical connections are installed and their function tested,
- a lockable main control switch is available to which the fan is connected
- the EMERGENCY-STOP equipment is functionally tested,
- the safety inspector has made sure that safety equipment exists,



- the operating personnel is familiar with the operating manual,
- the safety inspector has given his approval for the operation of the installation and that no external persons are present in the plant area

If envisaged by procedural regulations provided by the operator, minutes have to be taken on the commissioning work, including the observance of the check list.

## 4.2 Drive

The fan is driven by an electric motor which is connected either directly to the impeller shaft.

The motor electrical specifications are indicated on the motor's rating plate or in the motor manufacturer's data sheet.

When speed is controlled by means of a frequency converter, the maximum speed is limited by COLASIT to the value indicated on the manufacturer's rating plate.

If the frequency converter is not supplied by COLASIT, the operator is responsible for compliance with the maximum speed limitation. In this case, COLASIT will not assume any liability for damage that may be attributed to exceeding the maximum speed.

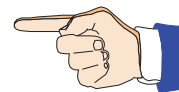

## 4.3 Electrical installations, EMERGENCY STOP

The electrical installations may only be carried out by an authorised electrician in accordance with the regulations prevailing at the site at which the fan is installed.

To interrupt the power supply, an EMERGENCY STOP switch must be provided. It is advisable to mount this switch in the vicinity of the emergency exit.

Please request confirmation from an in-house electrician that the electrical installations were carried out and tested in accordance with regulations, that all functions were tested (or simulated) and that the rotational direction is correct.

### Warning

Do not turn power on or off without prior warning to persons in the area where the fan is operating. Switching operations must be co-ordinated with other functions in the working area of the fan.

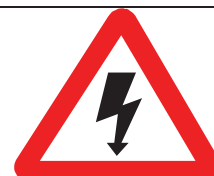

## 5 Operation

### 5.1 Safety instructions

The fan must be operated according to this manual. This will avoid the occurrence of any damage.

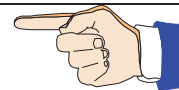

### Supervision

The fan must not be operated unattended as long as it conveys substances whose reactions are unknown or if unexpected reactions are anticipated. If supervision must be withdrawn for operational reasons, this must be reported to the safety officer and the system must be secured in such a way that no unauthorized intervention can be carried out. The safety officer must decide on issues regarding supervision.



## 5.2 Putting out of operation

An internal process instruction must regulate the work to be carried out as well as the preparatory work for putting back into operation (e.g. cleaning).

## 6 Maintenance, repair, cleaning

### 6.1 Preparation

Before any work is carried out on the fan, the fan must be set to its "safety position".

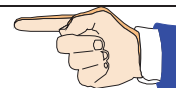

The „safety position“ is defined as follows:

- The drive must be currentless and the main switch secured against switching on,
  - The fan impeller can be manually rotated,
  - Fan must be flushed with fresh air and be condensate-free,
  - Fan must be at room temperature,
  - Personal protective equipment must be available and it must be worn. (Use of protective gloves because of sharp edges, ear protectors if necessary).
  - A sign, e.g. „Under-repair“, must be attached to the system,
  - The safety devices may be removed,
  - The work to be carried out must not be done under time pressure,
  - The general and specific regulations on accident prevention as well as the EKAS guidelines (Switzerland) must be observed,
  - The safety officer must be informed about the nature and course of the work,
- If the intake and delivery ducts of the fan are dismantled for a longer period of time, the openings must be closed off.

### 6.2 Performance

To establish if maintenance is necessary or to decide on the frequency of maintenance, regular visual inspection is necessary, especially in the initial phase of operation. Please check elastic connections on a half-yearly basis (intake and delivery connections as well as vibration absorbers) and replace them as soon as you discover any damage. The electrical motor is practically completely maintenance-free. Please remove dust deposits from the motor every time maintenance is done on the fan.

Components which are not intended for repair by the operator must be sent to the manufacturer or agent for repair or replacement (e.g. damaged impeller).

Your agent or COLASIT  
also offers customer services

Manufacturer	<b>COLASIT AG</b>
	P.O. 85
	CH 3700 Spiez / Switzerland
	Tel.: 0041 (0)33 655 61 61
Agent	Fax.: 0041 (0)33 654 81 61
	e-mail info@colasit.ch
	see front page

Deposits on the impeller and soiling lead to imbalance and as a result to vibrations with undesirable side effects.  
If vibration occurs, switch the fan off immediately



Contamination and encrustations should be removed with a soft tool without damaging the surface (e.g. with a wooden spatula or scraper). If possible, use water and a household cleaning agent

Solvents can corrode the material. These may only be used with the written consent of COLASIT.

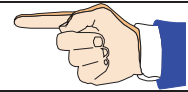

To carry out cleaning work, we recommend the production of a process instruction

## **7 Spare parts**

Please identify components by means of the position and drawing numbers as well as the order number and type designation.

Use only original spare parts. Our warranty becomes null and void if other or unapproved components are used.

Please address your spare parts order to our customer service department.

## **8 Operating instructions**

To operate the fan, we recommend the production of process instructions. These documents are intended to simplify repetitive workflows, reduce the risk of incorrect operation and are a valuable aid for training and when personnel changes occur.

If the fan must be qualified, process instructions are an absolute prerequisite.

You will find important instructions on how to produce process instructions in various chapters of this operating manual.

To help ensure the safe operation of the fan, COLASIT offers the service of reviewing process instructions prepared by the operator

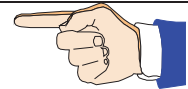

## **9 Logbook**

For your own safety and as an aid to personal responsibility, we recommend the keeping of a logbook for the entire period during which the fan is in service.

All events should be recorded in the logbook.

In case of damage and also in case of an accident, this document is the first source of information.

For example, enter the date and your signature:

- Start and end of a work cycle
- Special events, even if they do not concern the fan itself (e.g. power failure, alarm)
- Change of supervision staff (e.g. in case of shift operation),
- Repairs carried out and spare parts installed,
- Putting out of operation,
- Special instructions,
- etc.

## **10 Disposal**

Before disposing of plastics and other components (complete or as broken parts), please clean them as necessary to avoid any danger to the environment.

Dispose of the components properly. Instruct a waste disposal company to do this or return them to us for disposal.

## 11 Troubleshooting

If faults occur, we recommend you identify and clear them using the following table.  
If the fault cannot be cleared, please contact our customer service department.

Fault	Possible causes	Remedy
Fan not running smoothly	Impeller imbalance	Rebalance by specialist company
	Impeller caked up	Clean carefully rebalance if necessary
	Material corrosion on impeller due to aggressive conveyed medium.	Consult the manufacturer
	Impeller deformed due to high temperature.	Consult the manufacturer. Install new impeller. Check bearings
Fan output too low	Incorrect rotation direction of impeller	Change rotation direction
	Pressure losses in ducts too high	Change duct arrangement
	Restrictors not or only partly open	Check opening on site
Fan fails to reach its rated speed	Electrical switching mechanisms incorrectly adjusted	Check motor protection setting and reset if necessary
	Motor winding defective	Please consult the manufacturer
	Drive motor drive not correctly designed	Please consult manufacturer to verify starting torque

## 12 Retrofittable original accessories

If not already a part of our scope of supply, these original parts are available ex stock when ordered.

- Automatic damper
- Roof base in GFK

## Part 2: Units

### 13 Design and function of the CDVA

Axial-impeller with 12 or 14 blades

All impellers of this series are balanced out to better than Q6.3 according to VDI 2060.

Solid design, machined of fibreglass enforced plastic

## 14 Dimensional drawings

### 14.1 Dimensions of the CDVA

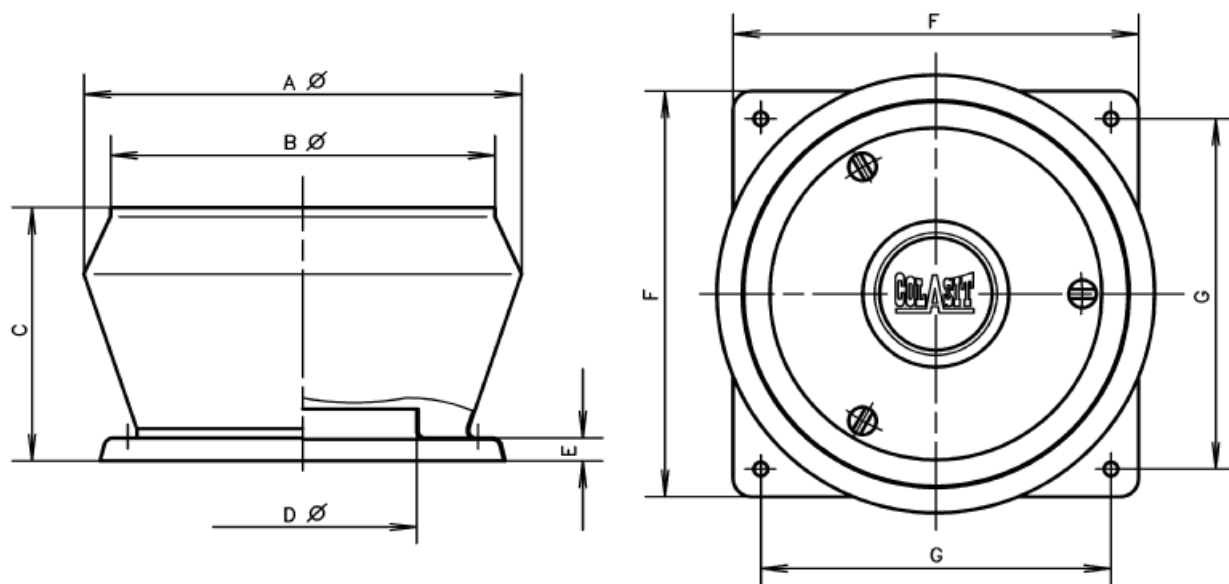

CDVA	400	450	500	560	630	710
A Ø	782	782	944	944	1154	1154
B Ø	700	700	835	835	980	980
C	440	440	530	530	620	620
D Ø	402	452	503	562	633	713
E	50	50	50	50	50	50
F	740	740	877	877	1070	1070
G	620	620	760	760	940	940

## Part 3: Certification

### 15 Certifications

#### 15.1 CE Manufacturer's declaration

**EG-Konformitätserklärung**  
CE Déclaration de conformité  
EC Declaration of conformity

Wir  
Nous  
We

COLASIT AG  
Postfach 85  
CH-3700 Spiez

erklären in alleiniger Verantwortung, dass das Produkt  
déclarons de notre seule responsabilité que le produit  
bearing sole responsibility, hereby declare that the product

**Kunststoff-Industrieventilator**  
**Ventilateur industriel en plastique**  
**Plastic industrial fan**  
**CDVA 400-710**

auf das sich diese Erklärung bezieht, mit der/den folgenden Norm(en) oder normativen  
Dokumenten übereinstimmt:

auquel se rapporte la présente déclaration est conforme aux normes ou aux documents normatifs  
suivants:

referred to by this declaration is in conformity with the following standards or normative documents:

Bestimmungen der Richtlinie Désignation de la directive Provisions of the directive	Titel und/oder Nummer sowie Ausgabedatum der Norm(en): Titre et/ou numéro ainsi que date d'émission de la/des norme(s): Title and/or number and date of issue of the standard(s):
2006/42/EG: Maschinensicherheit 2006/42/CE: Sécurité des machines 2006/42/EC: Machinery safety	SN EN ISO 12100: 2011 SN EN ISO 13857: 2008 SN EN 60204-1: 2006
2004/108/EG: Elektromagnetische Verträglichkeit 2004/108/CE: Compatibilité électromagnétique 2004/108/EC: Electromagnetic compatibility	SN EN 61000-6-2: 2005
Name und Adresse des Dokumentationsverantwortlichen: Nom et adresse de la personne responsable de la documentation: Name and address of the person authorised to compile the relevant technical documentation:	Andreas Roth COLASIT AG Faulenbachweg 63 CH-3700 Spiez

Spiez, 05.12.2012



U. Moser (Leiter Technik/Responsable dép. technique/Chief technical officer)

## 15.2 Further certificates

This operating manual has the following certificates enclosed:

- Design data sheets for the fan