

CMV	450	500	560	630	710	800
A	480	535	600	675	760	860
B	450	500	560	630	710	800
C	355	400	450	500	560	630
D	450	500	560	630	710	800
Ød	450	500	560	630	710	800
E	544	604	675	757	850	963
F	456	506	565	633	710	807
G	632	702	785	881	990	1119
H 0°	630	710	800	900	1000	1250
H 45°	630	710	800	900	1000	1120
H 90°	630	710	710	800	900	1000
H 135°	630	630	710	710	800	1000
H 270°	800	900	1000	1120	1250	1500
H 315°	710	800	900	1000	1120	1250
I	530	580	640	730	810	900
J	280	315	355	400	450	500
K	435	480	530	600	660	730
L	932	910	985	960	990	1025
M	700	700	700	700	700	700
N	330	330	330	330	330	330
O	127	150	175	200	300	265
P	60	60	60	60	60	60
Q	1000	1000	1100	1100	1230	1230
R	1175	1175	1275	1275	1405	1405
Øs	13	13	13	13	13	13
T	25	25	25	25	25	25
U	1070	1070	1070	1070	1070	1070
V	1120	1120	1120	1120	1120	1120

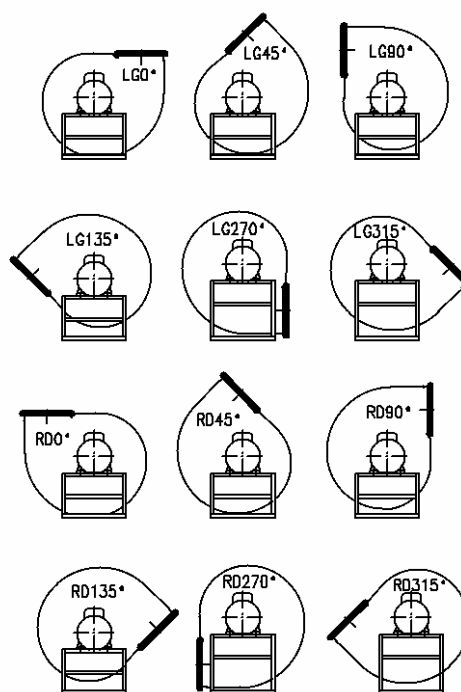

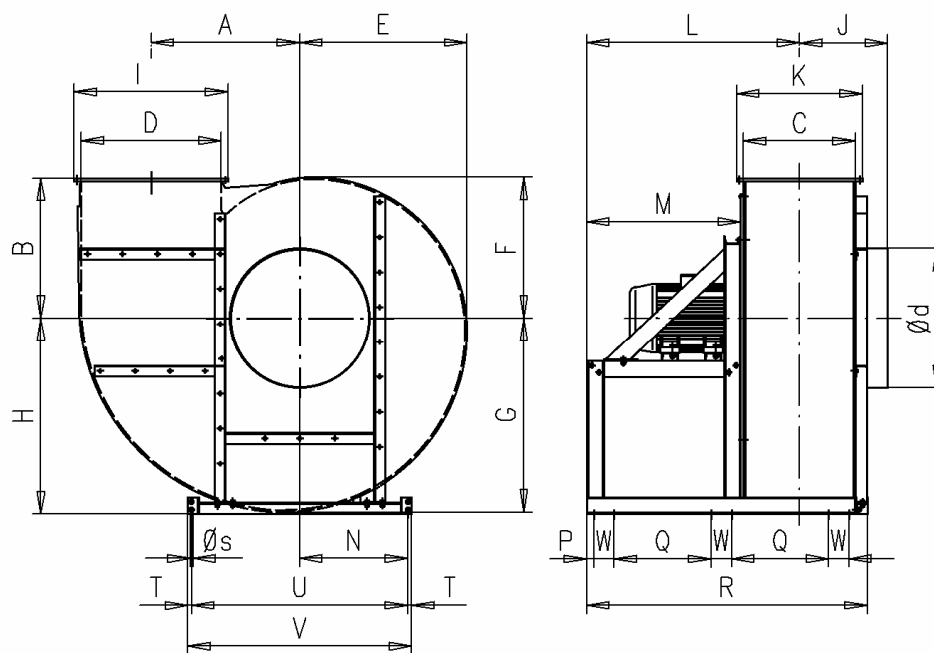

CMV	900	1000	1120	1250
A	964	1062	1200	1265
B	900	1000	1120	1120
C	710	800	900	1000
D	900	1000	1120	1250
Ød	900	1000	1120	1250
E	1081	1197	1377	1405
F	907	1007	1133	1155
G	1255	1387	1561	1655
H 0°	1250	1400	1600	1800
H 45°	1250	1400	1600	1600
H 90°	1250	1250	1400	1400
H 135°	1250	1250	1250	1400
H 270°	1600	1800	2100	2100
H 315°	1400	1600	1800	1800
I	1000	1100	1220	1350
J	560	630	710	800
K	810	900	1000	1100
L	1475	1520	1570	1620
M	1100	1100	1100	1100
N	772	772	772	772
P	50	50	50	50
Q	648	693	743	793
R	1915	2005	2105	2205
Qs	12	12	12	12
T	27.5	27.5	27.5	27.5
U	1545	1545	1545	1545
V	1600	1600	1600	1600
W	146	146	146	146

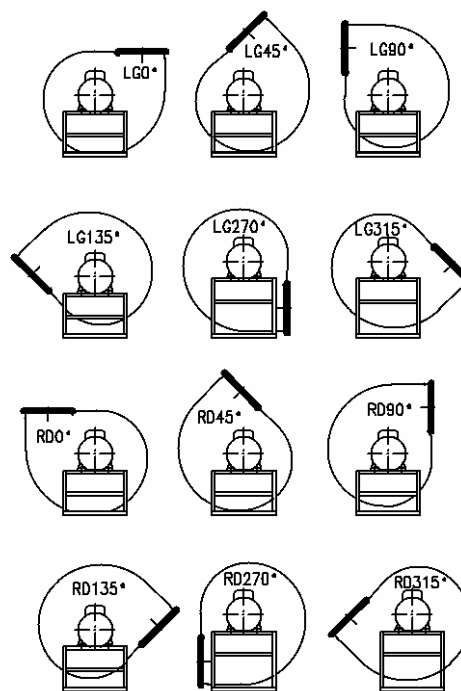

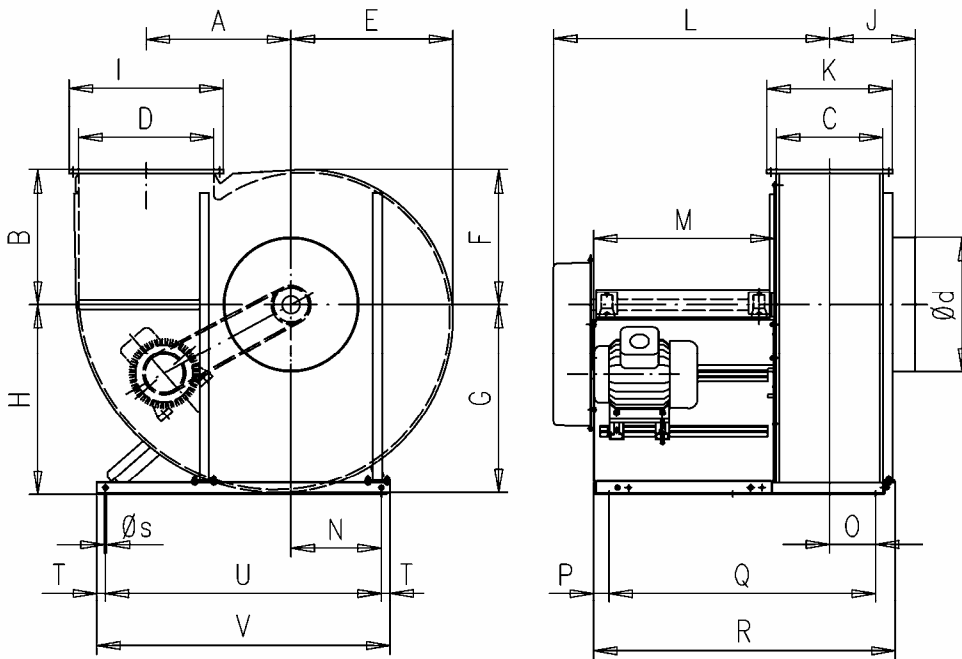

CMV	450	500	560	630	710	800
A	480	535	600	675	760	860
B	450	500	560	630	710	800
C	355	400	450	500	560	630
D	450	500	560	630	710	800
Ød	450	500	560	630	710	800
E	544	604	675	757	850	963
F	456	506	565	633	710	807
G	632	702	785	881	990	1119
H 0°	630	710	800	900	1000	1250
H 45°	630	710	800	900	1000	1120
H 90°	630	710	710	800	900	1000
H 135°	630	630	710	710	800	1000
H 270°	800	900	1000	1120	1250	1500
H 315°	710	800	900	1000	1120	1250
I	530	580	640	730	810	900
J	280	315	355	400	450	500
K	435	480	530	600	660	730
L	1132	1110	1185	1160	1192	1227
M	700	700	700	700	700	700
N	330	330	330	330	330	330
O	127	150	175	200	300	265
P	60	60	60	60	60	60
Q	1000	1000	1100	1100	1230	1230
R	1175	1175	1275	1275	1405	1405
Øs	13	13	13	13	13	13
T	25	25	25	25	25	25
U	1070	1070	1070	1070	1070	1070
V	1120	1120	1120	1120	1120	1120

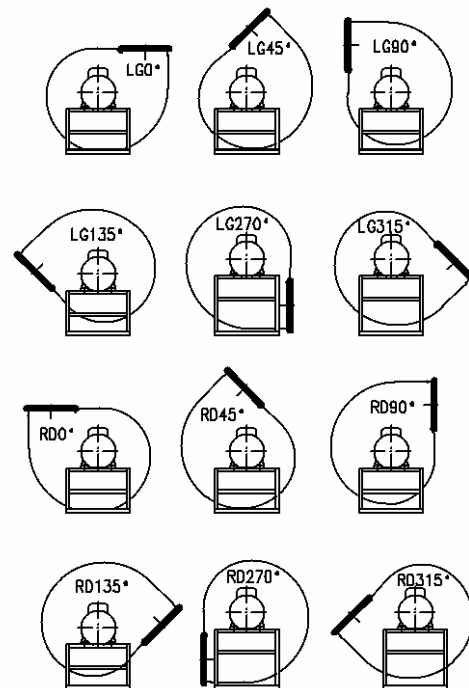

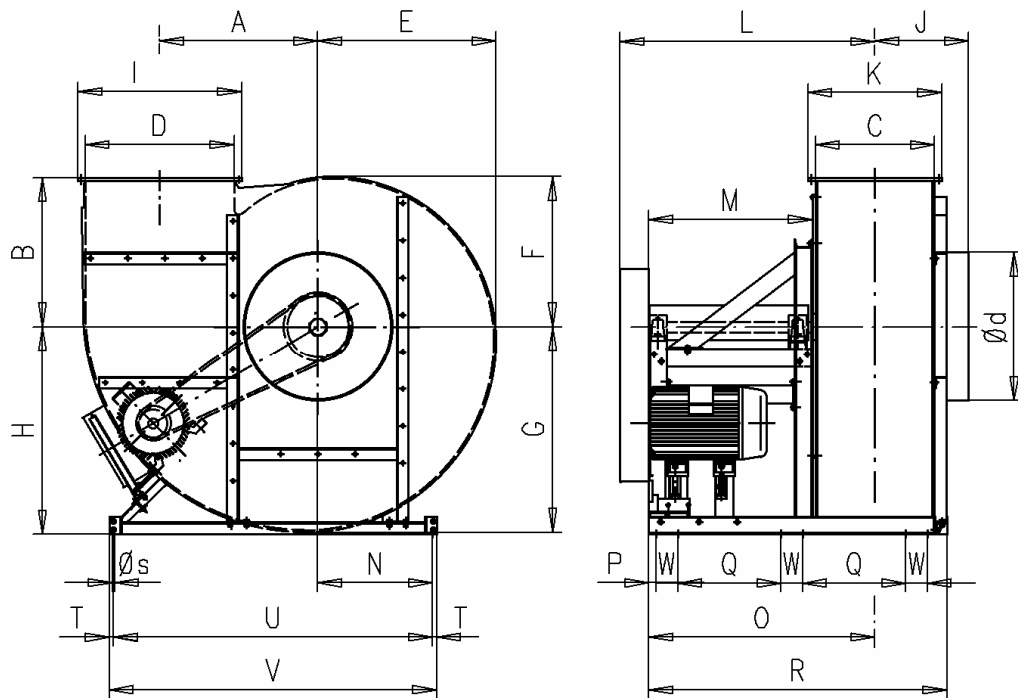

CMV	900	1000	1120	1250
A	964	1062	1200	1265
B	900	1000	1120	1120
C	710	800	900	1000
D	900	1000	1120	1250
Ød	900	1000	1120	1250
E	1081	1197	1347	1405
F	907	1007	1133	1155
G	1255	1387	1561	1655
H 0°	1250	1400	1600	1800
H 45°	1250	1400	1600	1600
H 90°	1250	1250	1400	1400
H 135°	1250	1250	1250	1400
H 270°	1600	1800	2100	2100
H 315°	1400	1600	1800	1800
I	1000	1100	1220	1350
J	560	630	710	800
K	810	900	1000	1100
L	1665	1710	1760	1810
M	1100	1100	1100	1100
N	772	772	772	772
O	1475	1520	1570	1620
P	50	50	50	50
Q	648	693	743	793
R	1915	2005	2105	2205
Qs	12	12	12	12
T	27.5	27.5	27.5	27.5
U	2145	2145	2145	2145
V	2200	2200	2200	2200
W	146	146	146	146

